



**EASY
INSTALL**



**CORDED
CONTROL**

FOREST CORDED Systems

Heavy duty corded curtain track systems with separate internal cord channels; preventing cord sag and eliminating cord tangle.

CKS[®] corded | Coded Klick System
CCS[®] corded | Coded Contract System
CRS[®] corded | Curtain Rod System
DS-XL[®] corded | Design System XL

THE WORLD
BEHIND
YOUR
CURTAINS



FOREST CKS® corded



PRODUCT INFORMATION

- Highly efficient cord traversing system with separate internal cord channels; preventing cord sag and eliminating cord tangle.
- Quick installation with "Smart Klick" brackets for wall and ceiling applications.
- Bendable; it can be bent and reverse bent by using a 10 cm (4") radius or continuous curved.
- Heavy duty clickable carriers - UV protected - for smooth and easy traversing. Offset shape for straight hanging pleats.
- Can also be used for ripplefold or accordiafold drapery systems.
- Maximum fabric weight: ± 6 kg per meter (4,5 LBS per ft.). Overall max weight, 40 kg.
- Colours available: white, grey and black.
- Available lengths: 4 meter (13'1"), 5 meter (16'4"), 6 meter (19'8"),).
- Track finish: chromated powder coated with a factory applied patented dry lubricant.
- Warranty: 10 years



25 mm
(1")

Clickable carrier



Easy installation
click - position - tighten

PROFILE

- Shown actual size 1:1
- Aluminium Extrusion
- Weight: 202 grams per meter (2.17 ounce per ft.)
- Dimensions: 14 mm x 20 mm (0,6" x 0,8").

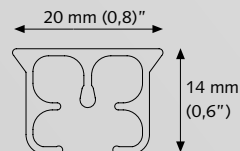

- 1 CKS Track
- 2 KS Carrier
- 3 CKS Master Carrier Overlap
- 4 CKS Master Carrier Underlap
- 5 CKS Pulley
- 6 Ceiling bracket with endcap



APPLICATIONS

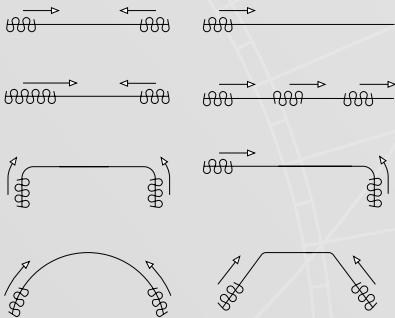

BENDING / CURVING

The track can be bent and reverse bent using a 10 cm (4") radius. Continuous curving can easily be done using the continuous curver or the electric powered bender.

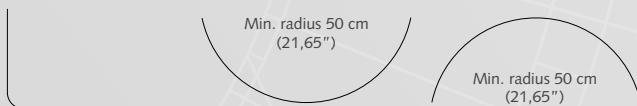

FOR USE IN

Hotels - offices - residences - boats - campers - planes or any location where an efficient cord traversing system is required.

MOUNTING BRACKETS

Wall bracket
3,5 cm (1,4"),
6 cm (2,4")

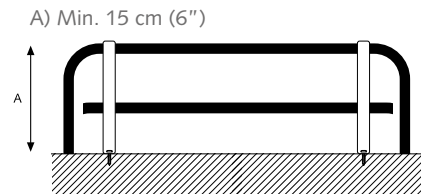
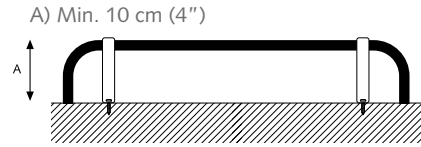
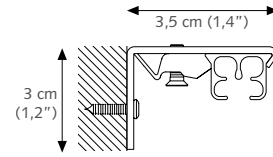

SK Ceiling Bracket

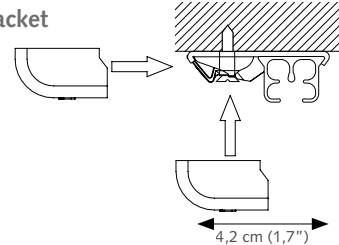

SK Wall bracket aluminium single

A) 7,5 cm (3")
B) 6,3 cm (2,5")

A) 10 cm (4")
B) 8,8 cm (3,5")

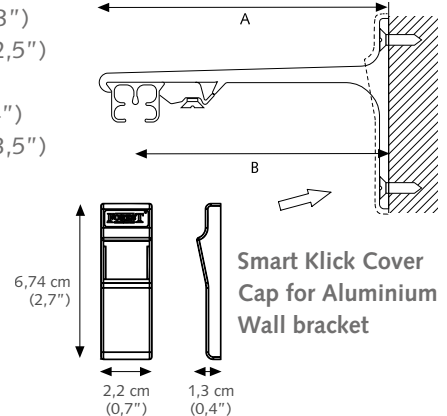

SK Wall bracket aluminium double

A) 15 cm (6") B) 9,2 cm (3,6") C) 4,5 cm (1,8")
A) 20 cm (8") B) 9,2 cm (3,6") C) 9,5 cm (3,7")

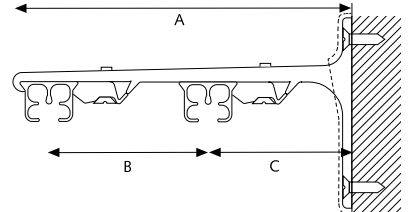

SK Wall bracket aluminium triple

25 cm (10")

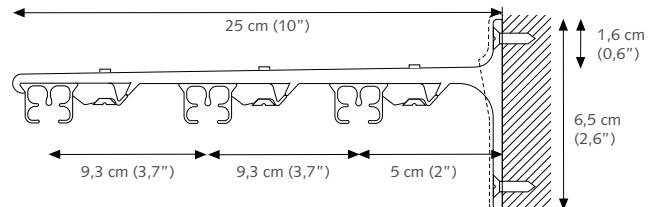

FOREST CCS[®] corded



PRODUCT INFORMATION

- Heavy duty cord operated system, with separate internal cord channels; preventing cord sag and eliminating cord tangle.
- Quick installation with "Smart Klick". brackets for wall and ceiling applications.
- Bendable; it can be bent and reverse bent with a 20 cm (8") radius or continuous curve.
- Heavy duty clickable carriers - 10 carriers on a breakaway strip - UV protected.
- Can also be used for Forest Easyfold and accordiafold drapery systems.
- Maximum fabric weight: 8 kg. per mtr (5,3 LBS per ft). Overall max weight, 50 kg.
- Colours available: white, grey & black.
- Track finish: chromated powder coating with a factory applied patented dry lubricant.
- Lengths available: 3.66 m (12'), 4.27 m (14'), 4.88 m (16'), 6.10 m (20').
- Same brackets as used with Klick System.
- Warranty: 10 years.



Easy installation
click - position - tighten



Clickable carrier

PROFILE

- Shown actual size 1:1
- Aluminium Extrusion
- Weight: 300 gram per mtr (3.22 ounce per ft)
- Dimensions: 20 mm x 20 mm (3/4" x 3/4")

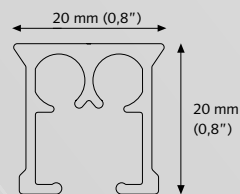

- 1 Carrier
- 2 CCS/FMS Master Carrier Underlap
- 3 Traverse cord
- 4 CCS/FMS Master Carrier Overlap
- 5 CCS Cord connector
- 6 CCS Track
- 7 Pulley



APPLICATIONS

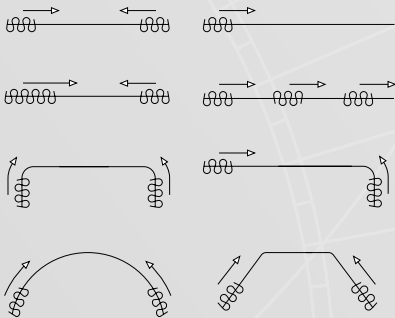

BENDING / CURVING

The track can be bent and reverse bent using a 20 cm (8") radius. Continuous curving can be done with the electric powered bender or by special order from factory.

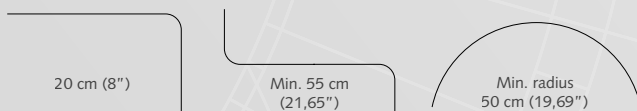

FOR USE IN

Hotels - motels - offices - healthcare - schools - residential or any location where a heavy duty cord traverse system is required.

MOUNTING BRACKETS

SK Ceiling Bracket

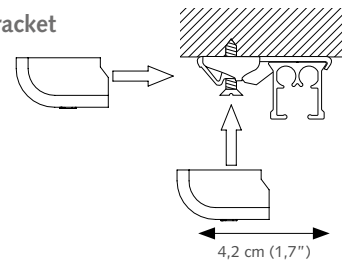

A) Min. 20 cm (8")

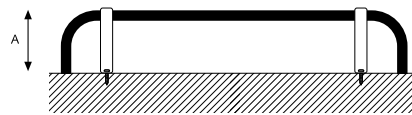

SK Aluminium Wall Bracket single

A) 7,5 cm (3") B) 6,3 cm (2,5")

A) 10 cm (4") B) 8,8 cm (3,5")

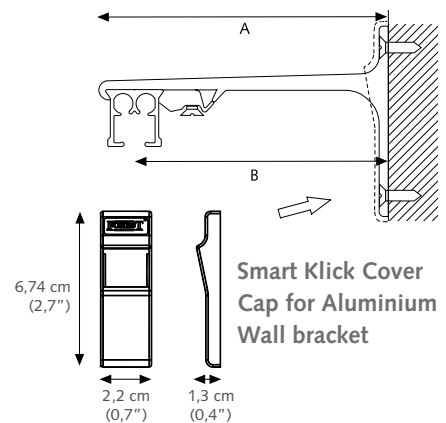

SK Wall bracket aluminium double

A) 15 cm (6") B) 9,2 cm (3,6") C) 4,5 cm (1,8")

A) 20 cm (8") B) 9,2 cm (3,6") C) 9,5 cm (3,7")

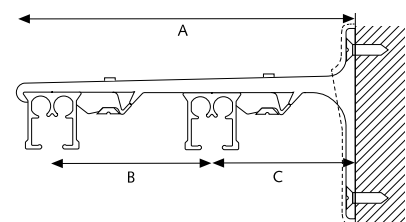

SK Wall bracket aluminium triple

25 cm (10")

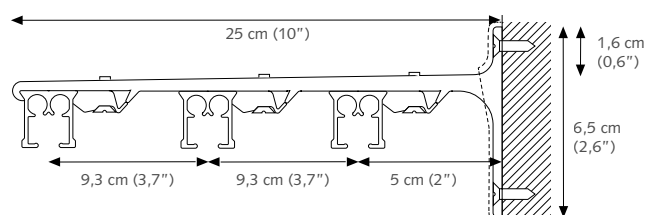

Brackets need to be placed every 50 - 60 cm (20"), depending on fabric weight.

FOREST CRS® Corded



PRODUCT INFORMATION

- Elegant and trendy cord-operated channel rod system
- Curtain rod fitted with curtain carriers
- Available dimension: 28 mm (1,1")
- Bendable, both with an inside and outside corner
- Available in 7 colours: White-PC, Gold-AN, Anthracite-PC, Chrome, Inox-AN, Taupe-PC, Antique-PC
- The brackets and endcaps are available in matching colours
- Wide range of decorative finials offering great variety of design options
- Length: 5,80 m (19")
- Rod quality: aluminium, chromated, powder coated or anodized
- Easy and quick assembly
- Forest Easyfold System (FES) for wave pleat also applicable on CRS Corded
- Warranty: 10 years.

PROFILE

- Shown actual size 1:1
- Weight: 460 grammes per meter
- Aluminium extrusion
- Dimension: 28 mm (1,1")

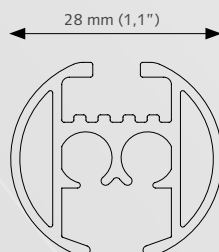

- 1 CRS corded End pulley
- 2 CRS channel rod
- 3 Traverse cord
- 4 MRS carriers
- 5 Easyflex master carrier 90° left
- 6 Easyflex master carrier 90° right
- 7 CRS corded end pulley base
- 8 CCS double cord connector
- 9 Ceiling bracket with slot



APPLICATIONS

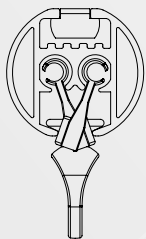

Cross-Section Channel Rod with cord connectors and carriers.

BENDING / CURVING

The 28 mm (1,1") rod can be curved and reverse curved by using a radius of 20 cm (8").

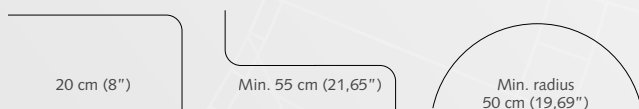

FOR USE IN

Domestic and / or contract market, or at any location where a high quality, elegant and corded operated channel rod system is required.

MOUNTING BRACKETS

CRS Ceiling Bracket

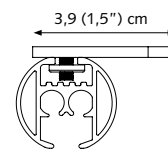

CRS Ceiling Support

4 cm (1,6"), 5 cm (2") or 10 cm (4").
20 mm (0,8")/ 28 mm (1,1").

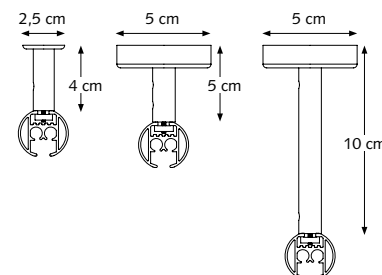

CRS Wall Bracket, single

8 cm (3,1"), 12 cm (4,7") and 16 cm (6,3")
(Base plate for the 12 cm (4,7") and 16 cm bracket is 6,2 cm (2,4"), similar to the double wall brackets.)

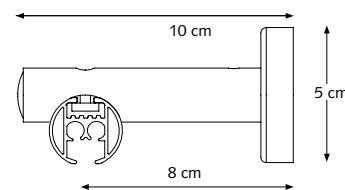

CRS Wall Bracket, double

16 cm (6,3")

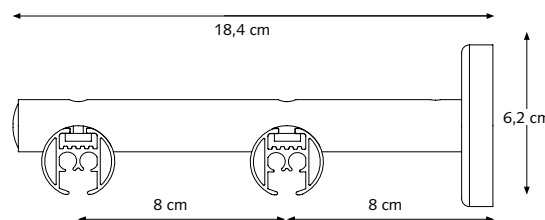

CRS Wall Bracket, double

16 cm (6,3") Ø 20 mm (0,8") (manual) / 28 mm (1,1") (corded)

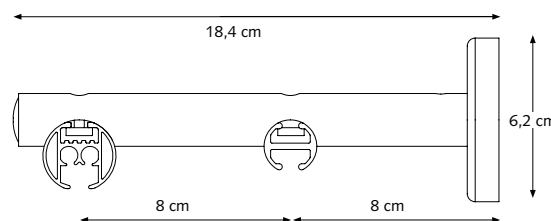

CRS Wall Bracket, double

20 cm (7,87") Ø 28 mm (1,1")

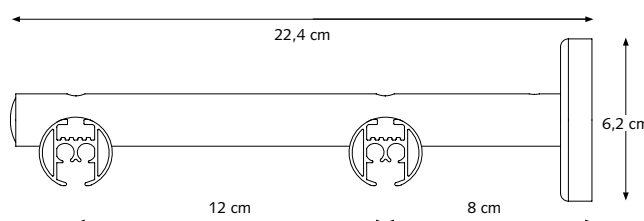

FOREST DS-XL® corded



With the DS-XL® Series, Forest offers curtain tracks that optimally combines design and functionality. The Design System XL gives every interior an extra visual appearance.

Stylish curtains deserve an elegant and fashionable curtain track. The DS-XL® Series provide a sleek finish and contribute to a unique design look at home or in any hotelroom.

Thanks to a symmetrical profile, the system can be mounted "blind" to the ceiling. This provides an extra sleek finish. The track is easy to mount by means of swivel supports or click supports.

The DS-XL® track system has been especially designed for use with our wave system, Forest Easyfold System. But it is also suitable with regular pleated curtain headings.

PRODUCT INFORMATIE

- Elegant and aesthetical corded curtain track system.
- For all types of medium weight draperies.
- Quick and easy installation.
- Ceiling brackets and wall brackets available.
- Invisible ceiling brackets to fix track flush to ceiling available.
- Heavy duty carriers - uv protected - for smooth and easy traversing.
- Colours available: white, grey or anthracite with matching assembly components.
- Available length: standard stock size 6 meter (19.8").
- Especially designed for use in combination with our wave pleat system 'Forest Easyfold System' .
- Unique warranty: 10 years.



PROFILE

- Shown actual size 1:1
- Weight: 480 gr/meter
- Aluminium extrusion
- Size: 60 x 15 mm
- Colours: white, grey, anthracite

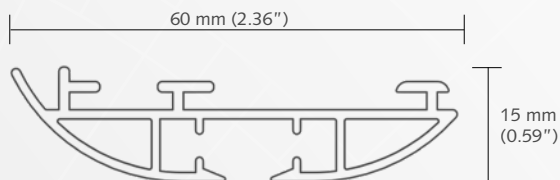

Easyflex tape application on DS-XL® track.

COLOUR OPTIONS

De DS-XL® is available in three colours: white, grey and anthracite.









FOR USE IN



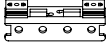
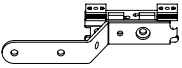
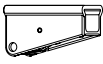

Hotels, offices, residences, boats, campers, planes or anywhere an efficient and elegant track system is required for curtains and drapes.

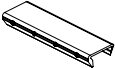





FOREST EASYFOLD SYSTEM

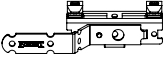
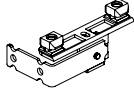
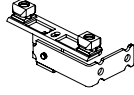
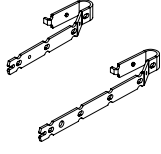
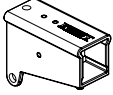

Opt for a regular pleated heading or choose for a more atmospheric effect for the Forest Easyfold System. The FMS® system has been designed for use with the Forest Wave-system. Our wave system is designed so that the curtains maintain their folding effect from the moment they are dressed.

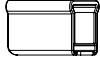
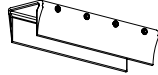





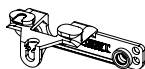
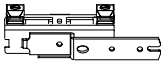
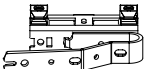

For more information about our wave system and basic components please refer to our Forest Easyfold brochure.

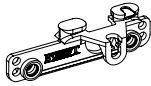
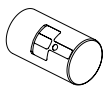
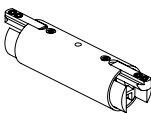

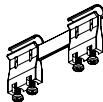

CKS corded	CCS corded	CRS corded	DS-XL corded	CKS TRACK+ PARTS	ARTICLE	PACKING UNIT	ART.NR
●					CKS TRACK 4 mtr. 5 mtr. 5 mtr. 5 mtr. 6 mtr.	20/bundle white white grey black white	1501001400 1501001500 1501003500 1501006500 1501001600
●					CARRIER ASYMMETRICAL "Klickable", offset, constructed of UV resistant plastic. 10 Carriers on a break-away strip. Can be clicked in after installation. Also symmetrical carriers available.	500/box white grey black	1010001000 1010003000 1010006000
●					CKS MASTER CARRIER UNDERLAP R/L Will go through curves.	25/box white grey black	1515601000 1515603000 1515606000
●					CKS MASTER CARRIER OVERLAP R/L Will go through curves.	25/box white grey black	1515701000 1515703000 1515706000
●					CKS PULLEY Reversible, for two way draw.	25/box white grey black	1530101000 1530103000 1530106000
●					CKS END PULLEY SHORT Especially for one-way closing of the curtain.	25/box white grey black	1530101011 1530103011 1530106011
●					CKS TRACK JOINER	10/box white grey black	1018401010 1018403010 1018406010
●					CKS CORD CONNECTOR Connects cord to the CKS Master Carrier. CKS CORD Connector Half Connects cord to the CKS Master Carrier.	100/box 100/box white black white	1530301000 1530306000 1530311000
●	●	●	●		TRAVERSE CORD Polyester drapery cord designed for smooth slide, Ø 3.5 mm (0,14"), 16 ply. Suitable for CKS / CCS / CRS / DS-XL Corded	250 mtr/roll white grey black	1030401000 1030403000 1030406000

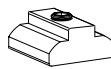

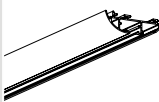

CKS corded	CCS corded	CRS corded	DS-XL corded	CCS TRACK+ PARTS	ARTICLE	PACKING UNIT	ART.NR
	●				CCS TRACK 3.66 mtr. 4.27 mtr. 4.88 mtr. 6.10 mtr. 6.10 mtr. 6.10 mtr.	10/bundle white white white white grey black	3001001366 3001001427 3001001488 3001001610 3001003610 3001006610
	●				CCS CARRIER SMALL Contract click carrier patented, clickable. UV-resistant POM plastic.	250/box white	2510101000
	●				FMS/CCS/MRS WHEEL CARRIER The wheel carrier goes smoothly over a splice.	100/box white	5210101002
	●				CCS CORD MASTER CARRIER R/L UNDERLAP Multifunctional - reversible arm - will go through curves.	15/box white grey gold black	3015601000 3015603000 3015602000 3015606000

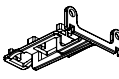

	●				CCS CORD MASTER CARRIER R/L OVERLAP Multifunctional - reversible arm - will go through curves, will also fit stiffeners and cord connector.	15/box	white grey gold black	3015701000 3015703000 3015702000 3015706000
	●				EASYFLEX MASTER CARRIER 90 DEGREE LEFT for center draw	15/box	white black	4815351090 4815356090
	●				EASYFLEX MASTER CARRIER 90 DEGREE RIGHT for center draw	15/box	white black	4815451090 4815456090
	●				PROLONGED ARM FOR MASTER CARRIER 150 mm long 150 mm long 150 mm long 150 mm long Click On 150 mm long Click On 200 mm long Click On	15/box	white grey black white black white	3016001000 3016003000 3016006000 9500001010 9500006010 9500001020
	●				CCS PULLEY Voor middensluitend pakket	25/box	white grey black	3030101000 3030103000 3030106000
	●				INSIDE WALL BRACKET For additional support anywhere the pulley meets the wall.	25/box		3022301000
	●				END PULLEY SMALL Reversible, for non-stacking side on one way draw.	25/box	white grey black	3030201000 3030203000 3030206000
	●				CCS RAIL CONNECTOR	10/box	white grey black	2518401000 2518403000 2518406000-A
	●	●			CCS CORD CONNECTOR Connects cord to the CCS master carrier.	100/box	white grey black	3030301000 3030303000 3030306000
	●	●			CCS DOUBLE CORD CONNECTOR Connects cord to the CCS master carrier.	20/box	white grey black	3030301010 3030303010 3030306010
●	●	●	●		TRAVERSE CORD Polyester drapery cord designed for strong smooth slide, Ø 3.5 mm (0,14"), 16 ply. Suitable for CKS/CCS/CRS/DS-XL Corded DS-XL Corded	250 mtr/roll	white grey black	1030401000 1030403000 1030406000

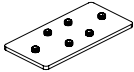







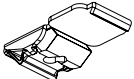
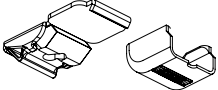
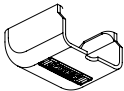
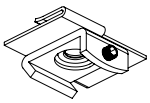
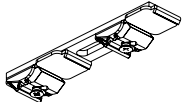
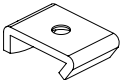
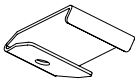
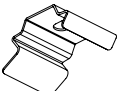

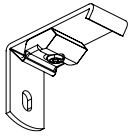
CKS corded	CCS corded	CRS corded	DS-XL corded	CRS TRACK+ PARTS	ARTICLE	PACKING UNIT		ART.NR
		●			CRS CHANNEL ROD CORDED Ø 28 mm (1.1") Extruded aluminium, chromated, powder coated incl. inlay strip	5.80 mtr/tube	white gold-an inox-an inox-pc antique-pc anthracite-pc chrome	5811281580-PC 5811282580 5811283580 5811283580-PC 5811289580-PC 5811286580-PC 5701287520
		●			CRS CARRIER ROUND	500/box	white grey black	5810101000 5810103000 5810106000
		●			EASYFOLD PLASTIC MASTER UNDERLAP	25/box	white grey black transparent	4815201010 4815203010 4815206010 4815201000
		●			FMS MASTER CARRIER UNDERLAP Multifunctional - arm is reversible for Click on stiffner	15/box	white grey black	5215801010 5215803010 5215806010
		●			FMS MASTER CARRIER OVERLAP Multifunctional - arm is reversible for Click on stiffner	15/box	white grey black	5215901010 5215903010 5215906010

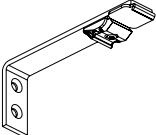
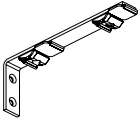
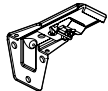
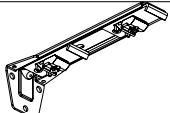

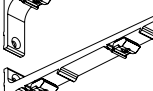

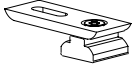
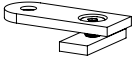

CKS corded	CCS corded	CRS corded	DS-XL corded	CRS TRACK+ PARTS	ARTICLE	PACKING UNIT		ART.NR
		●			EASYFOLD PLASTIC MASTER STRAIGHT/ OVERLAP	25/box	white grey black transparent	4815101010 4815103010 4815106010 4815101000
		●			CRS CORDED END PULLEY COMPLETE	2/box	white gold inox-an inox-pc antique-pc taupe-pc anthracite-pc	6130201001-PC 6130202001 6130203001 6130203001-PC 6130209001-PC 6130204001-PC 6130206001-PC
		●			CRS CORDED CENTRE PULLEY COMPLETE	2/box	white inox-an inox-pc antique-pc taupe-pc anthracite-pc	6130251001-PC 6130253001 6130253001-PC 6130259001-PC 6130254001-PC 6130256001-PC
		●			CRS RAIL CONNECTOR (6 CM)	10/box		5815200006
		●			CRS CORNER CONNECTOR (5 CM)	10/box		5815200007
	●	●			CCS CORD CONNECTOR	100/box	white grey black	3030301000 3030303000 3030306000
	●	●			CCS DOUBLE CORD CONNECTOR	100/box	white grey black	3030301010 3030303010 3030306010
●	●	●	●		TRAVERSE CORD Polyester drapery cord designed for smooth slide, Ø 3.5 mm (0,14"), 16 ply. Suitable for CKS / CCS / CRS / DS-XL Corded	250 mtr/roll	white grey black	1030401000 1030403000 1030406000
		●			CRS METAL ENDSTOP WITH SCREW for 20 mm (0,8") for 28 mm (1.1")	100/box		5816101000 5816101001
		●			CRS METAL ENDSTOP WITH SCREW-EYE for 20 mm (0,8") for 28 mm (1.1") Long, with ball bearings	100/box		5816102000 5816102001



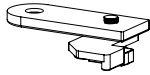

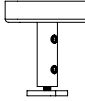

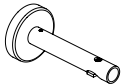
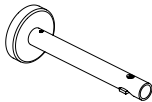
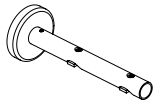
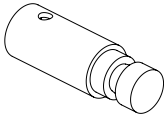
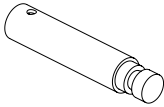
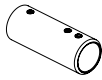
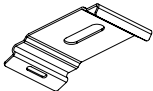

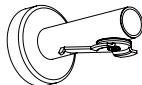
CKS corded	CCS corded	CRS corded	DS-XL corded	DS-XL TRACK+ PARTS	ARTICLE	PACKING UNIT		ART.NR
			●		DS-XL RAIL, 6 mtr (19"8")	24 mtr/bundle	white grey anthracite	3916101600 3916103600 3916106600
			●		ECONOMY CARRIER SMALL	500/box	white black	3910101000 3910106000
			●		EASYFLEX PLASTIC MASTER CARRIER 90 DEGREE	15/box	white grey black	3916701000 3916703000 3916706000
			●		DS-XL ENDCAP CORDED	20/box	white grey black	3916201000 3916205000 3916206000

			●		DS-XL TRACK CONNECTOR STRAIGHT	10/box		3916401000
			●		DS-XL CORD CONNECTOR	100/box	white black	1530301000 1530306000
●	●	●	●		TRAVERSE CORD Polyester drapery cord designed for smooth slide, Ø 3.5 mm (0,14"), 16 ply. Suitable for CKS / CCS / CRS / DS-XL Corded	250 mtr/roll	white grey black	1030401000 1030403000 1030406000
			●		DS-XL END STOP	100/box		3916001000

CKS corded	CCS corded	CRS corded	DS-XL corded	MOUNTING	ARTICLE	PACKING UNIT		ART.NR
●	●				CEILING BRACKET Slides onto the track, powder coated. Regular duty	100/box	white grey black beige	1018001000 1018003000 1018006000 1018012000
●	●				CEILING BRACKET WITH SLOT Slides onto the track, powder coated. Regular duty Slotted support makes fixing curtain track easier.	100/box	white grey black creme beige	1018101000 1018103000 1018106000 1018111000 1018112000
●	●				SMART KLICK CEILING BRACKET Powder coated, "clicks" onto track. Attach with VK-4 mm screw.	100/box	white grey black	1018201000 1018203000 1018206000
●	●				SMART KLICK CEILING BRACKET INCL. COVER CAP	100/box	white grey black	1018201001 1018203001 1018206001
●	●				COVER CAP FOR SMART KLICK BRACKETS Suitable for Smart Klick Wall-and Ceiling bracket.	100/box	white grey black anthracite	1019201000 1019203000 1019206000 1019206600
●	●				FALSE CEILING BRACKET (METAL) For installation on to a suspended ceiling. The track can be fixed in any angle.	25/box		4519001000
●	●				SMART KLICK DOUBLE CEILING BRACKET LARGE Distance between two tracks: 90 mm (3,5")	30/box	white	1018601000
					SMART KLICK DOUBLE CEILING BRACKET SHORT Distance between two tracks: 45 mm (1,8")			1018611000
●	●				FSS MOUNTING BRACKET For concealed installation or ceiling installation in narrow spaces. Heavy Duty.	100/box		7160001000
●	●				KS CEILING SPLICE BRACKET For ceiling installation only, powder coated.	50/box	white grey black	1018501000 1018503000 1018506000
●	●				KS KLICK-ON CEILING BRACKET WHITE For concealed installation without visible brackets, light weight use only.	100/box	white grey black	1018301000 1018303000 1018306000

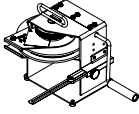
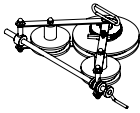
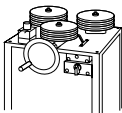
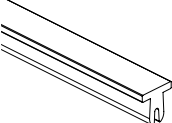
CKS corded	CCS corded	CRS corded	DS-XL corded	MOUNTING	ARTICLE	PACKING UNIT		ART.NR
●	●				SMART KLICK WALL BRACKET 3,5 cm "Klicks onto track, powder coated. One screw attachment. For light weight use only.	50/box	white grey black	1020201035 1020203035 1020206035
●	●				SMART KLICK WALL BRACKET 6 cm "Klicks onto track, powder coated. One screw attachment. For light weight use only.		white grey black	1020201060 1020203060 1020206060
					SMART KLICK WALL BRACKET 7,5 cm "Klicks onto track, powder coated. One screw attachment. For light weight use only.		white grey black	1020201075 1020203075 1020206075
●	●				KS SMART KLICK WALL BRACKET 10 cm	20/box	white grey	1020201100 1020203100
					KS SMART KLICK WALL BRACKET 12,5 cm	20/box	white grey	1020201125 1020203125
					KS SMART KLICK WALL BRACKET 15 cm	15/box	white grey	1020201150 1020203150
					KS SMART KLICK WALL BRACKET 20 cm	15/box	white grey	1020201200 1020203200
					KS SMART KLICK WALL BRACKET 25 cm	10/box	white grey	1020201250 1020203250
					KS SMART KLICK WALL BRACKET 30 cm	10/box	white grey	1020201300 1020203300
●	●				KS SMART KLICK WALL BRACKET DOUBLE For light weight use only.	15/box	10 cm 15 cm 20 cm	1020601100 1020601150 1020601200
●	●				KS ADJUSTABLE WALL BRACKET, SINGLE	100/box	white grey	1020801115 1020803115
●	●				KS ADJUSTABLE WALL BRACKET, DOUBLE	50/box	white grey	1020801195 1020803195
●	●				ALUMINIUM SK WALL BRACKET 7,5 CM SINGLE. "Klicks onto track, powder coated.	20/box	white grey black	1020301075 1020303075 1020306075
					ALUMINIUM SK AFSTANDSTEUN 10 cm ENKEL. "Klicks onto track, powder coated.	20/box	white grey black	1020301100 1020303100 1020306100
					ALUMINIUM SK AFSTANDSTEUN 15 cm DUBBEL. "Klicks onto track, powder coated.	15/box	white grey black	1020301150 1020303150 1020306150
					KS ALUMINIUM SK AFSTANDSTEUN 20 cm DUBBEL. "Klicks onto track, powder coated.	15/box	white grey black	1020301200 1020303200 1020306200
					ALUMINIUM SK AFSTANDSTEUN 25 cm TRIPLE. "Klicks onto track, powder coated.	10/box	white grey black	1020301250 1020303250 1020305250
●	●				SMART KLICK COVER CAP ALUMINIUM BRACKET UNIVERSAL	50/box	white grey black	1021301000 1021303000 1021306000
		●			CRS CEILING BRACKET Ø 20/28 MM with slot	100/box	aluminium	5818003000
		●			CRS CEILING BRACKET Ø 20/28 MM with hole	100/box	white inox	5818003101 5818003103
		●			MRS CEILING BRACKET SMALL, 1,5 CM	4/box	chrome	5718407050

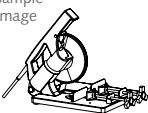
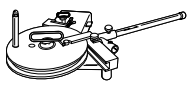
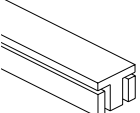
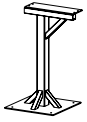
CKS corded	CCS corded	CRS corded	DS-XL corded	MOUNTING	ARTICLE	PACKING UNIT	ART.NR
		●			CRS SWIVEL FOR 28 MM ROD	100/box	5863001000
		●			CRS CEILING SUSPENSION BRACKET 4 CM (1.57") Ø 20/28 MM	2/box	white gold inox-an inox-pc black antique-pc anthracite-pc chrome 5818112000 5818122000 5818132000 5818132000-PC 5818162000-PC 5818192000-PC 5818152000-PC 5818012028
		●			CRS CEILING SUSPENSION BRACKET 5 CM (1.96") Ø 20/28 MM	2/box	white gold inox-an inox-pc antique-pc 5818112028 5818122028 5818132028 5818132028-PC 5818192028-PC
		●			CRS WALL BRACKET SINGLE 8 CM (3.15") Ø 28 MM	2/box	white gold inox-an inox-pc black antique-pc taupe-pc anthracite-pc chrome 5820080128 5820080228 5820080328 5820080328-PC 5820080628-PC 5820080928-PC 5820080428-PC 5820080528-PC 5820080728
		●			CRS WALL BRACKET SINGLE 12 CM (4.72") Ø 28 MM	2/box	white gold inox-an inox-pc black antique-pc taupe-pc anthracite-pc chrome 5820120128 5820120228 5820120328 5820120328-PC 5820120628-PC 5820120928-PC 5820120428-PC 5820120528-PC 5820120728
		●			CRS WALL BRACKET SINGLE 16 CM (6.29") Ø 28 MM	2/box	white gold inox-an inox-pc black antique-pc taupe-pc anthracite-pc 5820160128 5820160228 5820160328 5820160328-PC 5820160628-PC 5820160928-PC 5820160428-PC 5820160528-PC
		●			CRS WALL BRACKET DOUBLE 16 CM (6.29") Ø 28 MM	2/box	white gold inox-an inox-pc black antique-pc taupe-pc anthracite-pc 5822160128 5822160228 5822160328 5822160328-PC 5822160628-PC 5822160928-PC 5822160428-PC 5822160528-PC
		●			CRS WALL BRACKET EXTENSION 4 CM	10/box	white gold inox-an inox-pc black antique-pc anthracite-pc chrome 5815201030 5815202030 5815203030 5815203030-PC 5815206030-PC 5815209030-PC 5815205030-PC 5715107040
		●			CRS WALL BRACKET EXTENSION 8 CM		gold inox-an inox-pc black antique-pc chrome 5815102020 5815103020 5815103020-PC 5815106020-PC 5815109020-PC 5715107080
		●			CRS ADJUSTABLE BRACKET EXTENSION	10/box	white inox-an inox-pc black antique-pc 5815101070 5815103070 5815103070-PC 5815106070-PC 5815109070-PC
		●			DS-XL KLIKK CEILING BRACKET	100/box	3918301000
		●			DS-XL CEILING SWIVEL BRACKET	100/box	white anthracite 3818200230 3818205230
		●			DS-XL WALL BRACKET 9 CM	5/box	white anthracite 3820001018 3820005018

CKS corded	CCS corded	CRS corded	DS-XL corded	BUIGONDERDELEN EN OVERIGE ITEMS	ARTICLE	PACKING UNIT		ART.NR
●	●	●	●		TENSION PULLEY White	25/box		1030501000
●	●	●	●		ASSEMBLY TOOL FOR CORD CONNECTOR	1/each		9510000027
●	●	●	●		CORD/CHAIN WALL MOUNT SAFETY BOX SINGLE	25/box		3645702000
●	●	●	●		CORD/CHAIN WEIGHT DESIGN 110 GR WIT	10/box	white grey black	3030701000 3030703000 3030706000
●	●	●	●		CHANNEL ROD LUBRICANT SPRAY To lubricate components during assembly.	1/each		5109020000
●					COMPACT BENDING HOUSE, FOR KS/CKS	1/box		1050000000
					CKS BENDING WHEEL ALL-IN incl. strips (60cm)			1051000000
●					CONTINUOUS CURVER Add on tool for the Compact Bending Tool. Designed to create continuous curves and arches in any radius. Includes KS bending strip. For KS and CKS Track only.	1/box		1060200000
●	●				ELECTRIC POWERED BENDER For creating continuous curves. Minimum radius 50 cm.	1/box	230V 110V	1060500000 1060500001
●					CKS REPLACEMENT BENDING STRIP For Compact Bending Tool. Length of strip: 60 cm (23")	1/each		1560100000
					For Continues Curver / electric bender. Length of strip: 7 mtr. (23")			1560300000
●					BENDING WHEELS For electric powered bender. Complete set of 3 wheels.	1/set		1060700000 2560700000
●	●			sample image 	ELECTRIC POWERED RAILCUTTER 230 Volt EU	1/each		1061100000
					BLADE FOREST CUTTER NEW MODEL	1/each		1061200001
	●				CONTRACT BENDING TOOL For CS/CCS/FMS/CRS/MTS	1/each		2560000000
					CS/CCS/FMS Bending Wheel	1/each		2561000000
	●				CCS BENDING STRIPS, COMPLETE SET For CCS track, length: 90 cm.	1/set		8500000002
					FOR CCS ELECTRIC POWERED BENDER. Length 7 meter (23').	1/each		8500000010
	●				BENDING STANDARD Standard for Contract bending tool 28 mm	1/each		2560800000
	●				BENDING WHEELS For Electric Powered Bender. Complete set of 3 wheels only for CS en CCS rail.	1/set		2560700000